



## SECTION 7 MAINTENANCE

### 7.1 Introduction

Section 7 contains technical information required to effectively and efficiently service and repair the Crown D-150A. Included are disassembly and reassembly procedures, required test equipment lists, checkout procedures, basic troubleshooting tips and a soldering technique review.

**THIS INFORMATION IS INTENDED FOR USE BY AN EXPERIENCED TECHNICIAN ONLY!**

Use this information in conjunction with the Instruction Manual, schematic/board layout diagrams, parts lists and exploded view drawings (the latter located in Section 6 of this manual).

### 7.2 Required Test Equipment

Many of the service and repair problems with the D-150A can be performed with a limited amount of test equipment. However, in order to return the unit to its "factory new" specifications, the following list of required test equipment is recommended. The "Requirements" column provides information to allow intelligent selection of substitutes if the "Suggested Supplier and Model" is not available or is considered impractical to obtain.

EQUIPMENT	REQUIREMENTS	APPLICATION	SUGGESTED MODEL
Oscilloscope	Capable of displaying a 10MHz signal	Monitoring output during service and testing	Tequipment D54A or equivalent
Volt-ohmmeter (VOM)	Low-voltage resistance probe (100mv range). High-voltage resistance probe (1.5V range)	Check resistance values (low voltage probe). Check semiconductor junctions for opens or shorts (high voltage probe) Check DC voltages	Triplett 601 or equivalent
Freq. Counter		For accurate general monitoring	Heath SM118A
Signal Generator	Sine/Square wave available; flat frequency response. THD. .1% maximum	Provide test signals for service and checkout	Wavetek 130-Series or equivalent
Circuit Breaker	15 ampere rating	In AC line to unit; protects circuitry from overload if power supply has shorted	
AC Line Voltage Monitor	Peak reading meter (displays rms equivalent to a sinusoidal peak for any wave form)	Monitor Line voltage	Available from CROWN

EQUIPMENT	REQUIREMENTS	APPLICATION	SUGGESTED MODEL
Phase Meter			
AC Voltmeter	100mv low range, flat frequency response to 100KHz	Set output level for testing; check noise level	Hewlett-Packard 400F or equivalent
Filter	20-20KHz bandpass, low noise 20Hz-20KHz	Between preamplifier and voltmeter in noise test	Information available from CROWN
Intermodulation Distortion Analyzer	Residual (.002% or lower)	Check IM distortion	Information available from Crown

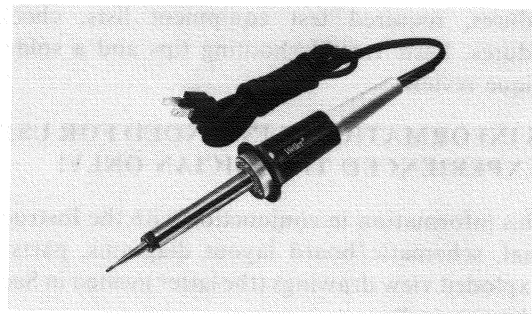
### 7.3 Soldering Techniques

**Note:** Proper continuity between internal components of any electronic device is the key to its successful operation. Therefore, a brief review of the following discussion on soldering techniques may be in order. Because most service work involves component part(s) replacement, hand-soldering with the use of a soldering iron will be the only method covered, even though many exist.

The difference between success and failure in service repair is often determined by the thermal characteristics of an iron and how well it matches the job at hand. One would not use a large flat-head screwdriver to work on a delicate Swiss watch. Likewise, the proper size iron and tip should be used when soldering delicate electronic parts in position.

Iron wattage classification is actually not a very good method of choosing an iron. The reason for this is because of the possible inefficiency of heat transfer to the tip internally. A large wattage iron (125W) may, in effect produce lower tip temperatures than another iron smaller in wattage. Likewise, tip size and shape does not necessarily work in proportion to temperature. Therefore, it is impractical to compare soldering irons by their wattage but more feasible to refer to them by their maximum tip temperature.

Usually, the skilled service technician can pick the right iron and tip for the job from experience or recommendation. In most cases, the miniature or small electrical soldering iron will work well with delicate semiconductor devices (Fig. 7.1). When the proper size iron is used (usually around 700° F. tip temperature), a joint is almost instantly heated (approx. 500-550°) and application of iron and solder melting is simultaneous.

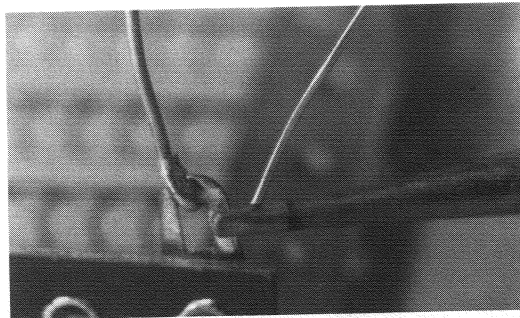
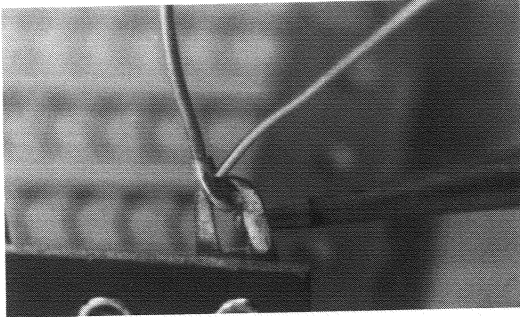


*Fig. 7.1 Miniature Soldering Iron*

When clean metal is exposed to air a chemical reaction takes place known as oxidation. When heat is applied to metal, oxidation is speeded up and creates a non-metallic film that prevents solder from touching the base metal. By applying a small amount of solder to a hot iron tip, a desirable process known as tinning occurs. The main reason for tinning an iron is to help prevent it from oxidizing as well as to aid in heat transfer. Tinning should be performed prior to each use as well as after long idling times.

To help prevent oxidation or remove existing oxidation while soldering, a natural rosin flux core solder should be used. Not only does flux aid in cleaning, but acts as a catalyst in that it helps speed up the joint formation without actually entering itself, into the bond. Never use an acid flux except to clean a highly oxidized tip that will not tin correctly. Crown recommends 63% tin/37% lead composition with a rosin flux core of 2.5% (melting temperature is approx. 361°F.).

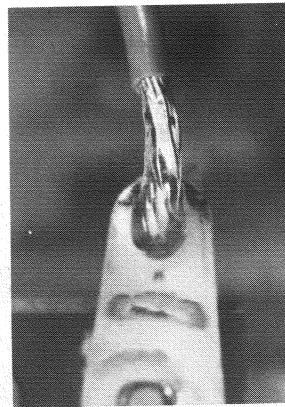
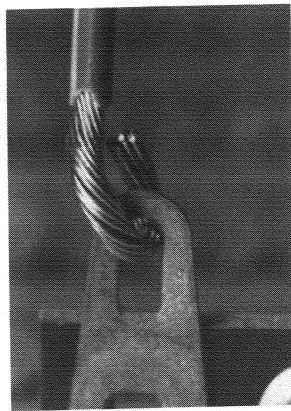
Fig. 7.2 shows the correct and incorrect method of applying rosin flux core solder to a joint. Never apply solder to the iron tip directly and allow solder to run onto the joint (flux is burned away and does not clean the joints). Always apply heat to the connection and allow the joint to melt the solder, not the iron. This insures proper wetting and flow of the solder.



*Fig. 7.2 Correct and Incorrect Solder Application*

**Problem:** Unsoldered wire.

**Characteristics:** Properly assembled junction of wire, but without any solder.



*Fig. 7.3 Unsoldered Wire*

**Cause:** Solder not applied.

**Remedy:** Correct amount of solder applied properly.

One of the main advantages of using solder to make connections is that it is one of the few joining methods responsive to visual examination. This permits 100% inspection, while other methods require sampling and lengthy electrical tests. With proper inspection of materials used, soldering is the most reliable, time-improved, and versatile form of electrical joining offering the benefits of economy, dependability and speed.

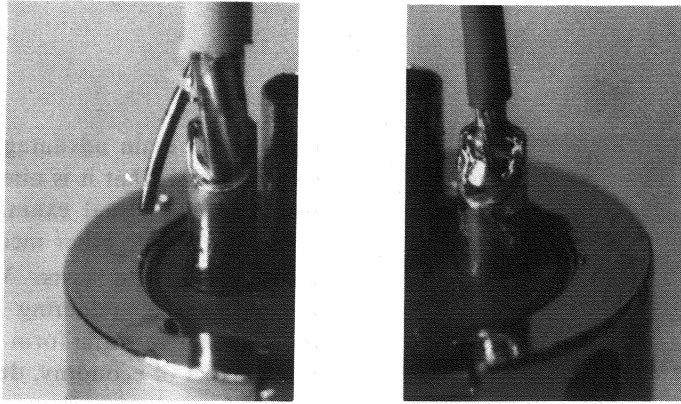
A good solder joint will have the following recognizable features:

- a) Proper wetting - mixing of molecules to form a singular, shiny bond of metal
- b) Proper flow - feathering out of solder
- c) Proper contour - outline of wire under solder
- d) Proper fillet - solder filling in holes and crevices.

Because visual inspection is an important part of recognizing a good solder joint, the following examples have been provided to help with familiarization.

**Problem:** External strands.

**Characteristics:** One or more strands of wire outside terminal. This defect most common when cup-type terminals are utilized.



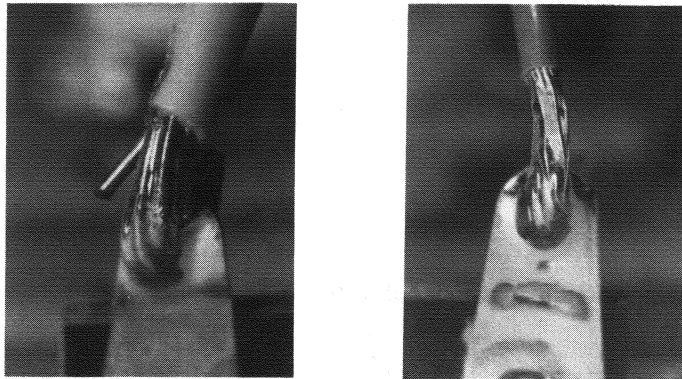
*Fig. 7.4 External Strands*

**Cause:** Poor assembly operation, too large diameter wire used.

**Remedy:** Correct diameter wire tinned prior to insertion.

**Problem:** Cut strands.

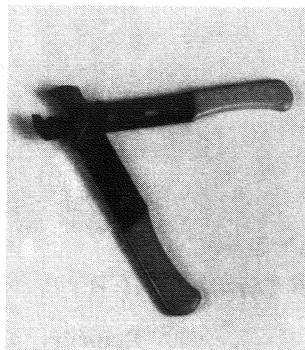
**Characteristics:** Several strands of wire cut or broken and usually not soldered to terminal.



*Fig. 7.5 Cut Strands*

**Cause:** Improper wire stripping; wire flexed or bent excessively during or after assembly.

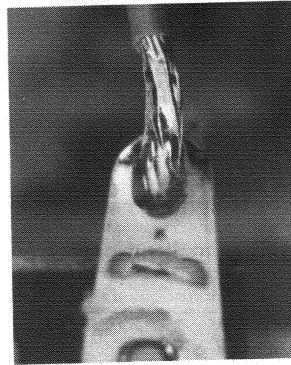
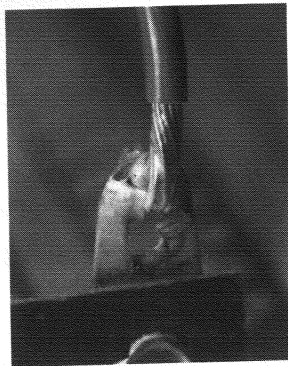
**Remedy:** Use wire strippers similar to the one shown in Fig. 7.6 . Care must be taken to avoid nicking or cutting.



*Fig. 7.6 Wire Strippers*

**Problem:** Disturbed joint.

**Characteristics:** Rough appearance with questionable adhesion.



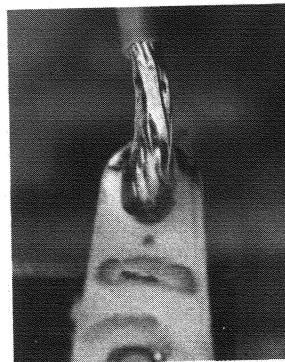
*Fig. 7.7 Disturbed Joint*

**Cause:** Movement of wire/joint during cool-off stage.

**Remedy:** Use of holding vice or similar tool to help prevent movement.

**Problem:** Cold solder joint.

**Characteristics:** Joint with dull, frosty appearance; often has poor adhesion as well as imperfect shaping.



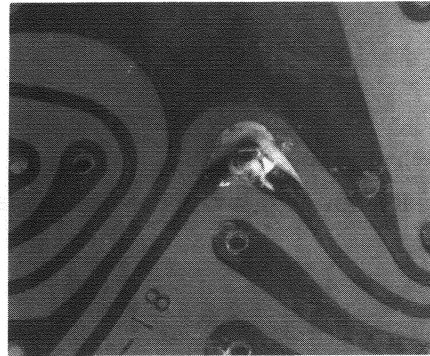
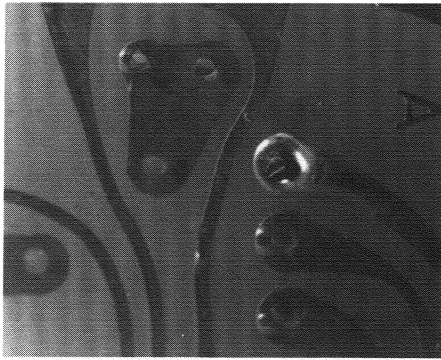
*Fig. 7.8 Cold Solder Joint*

**Cause:** Too much heat applied (flux is boiled off before oxide removal action takes place).

**Remedy:** Correct matching of iron/tip to specific job.  
Correct solder flux combination is also important.

**Problem:** Rosin joint.

**Characteristics:** Joint is separated by a thin coat of flux producing high resistance to current.



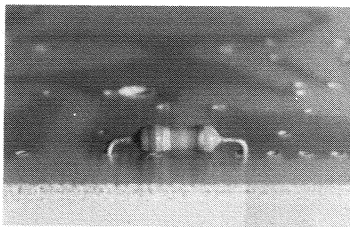
*Fig. 7.9 Rosin Joint*

**Cause:** Solder applied previous to terminal reaching minimum temperature (solder melting point).

**Remedy:** Apply correct amount of heat; remove only after good wetting and fillet is achieved.

When soldering individual component parts to printed circuit boards, several procedures may be followed. The following procedure complies to U.S. Government standards and may be altered to suit a specific situation.

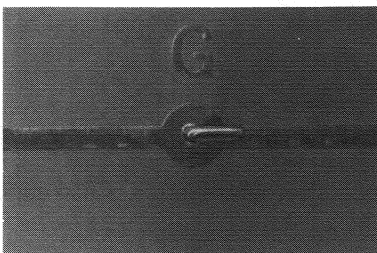
1. Components leads should be bent to exact spacing of mounting holes in PC board (Fig. 7.10). This allows leads to enter PC board at right angles and relieves stress.



*Fig. 7.10 Component Lead Spacing*

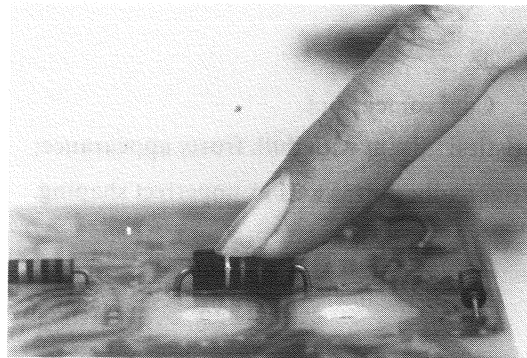
2. Leads should be bent down tight to pad.

3. Leads should be bent in the direction of the run connected to the pad and clipped at a length approximately  $\frac{1}{8}$ " (Fig. 7.11).

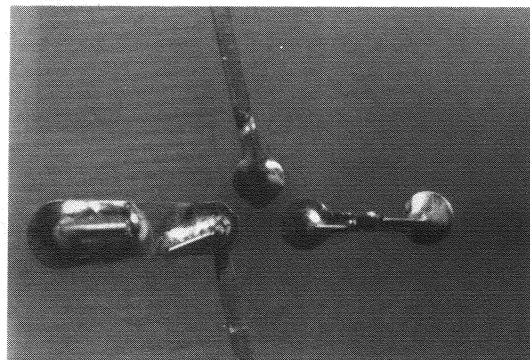


*Fig. 7.11 Component Lead Bending*

4. Components should be held tight to the PC board while clinching leads on other side (Fig. 7.12) and soldered accordingly. Fig. 7.13 shows acceptable solder joints.

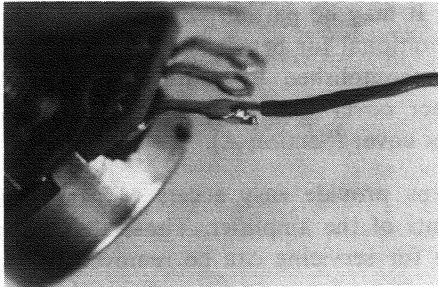


*Fig. 7.12 Correct Pressure Applied*



*Fig. 7.13 Acceptable Solder Joints*

When soldering to lugs (as on potentiometers), the mechanical wire wrap should be a J hook with correct insulation clearance as shown in Fig. 7.14.



*Fig. 7.14 Soldering to a Lug*

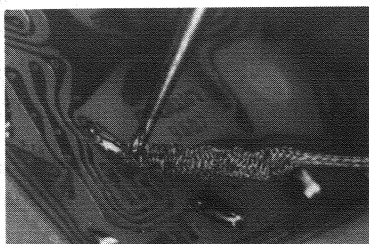
Turret terminals also utilize the “J” hook (Fig. 7.15). Concentrate on good heat transfer to the terminal first, then the wire. If two wires are to be soldered, be sure of good solder flow to all three.



*Fig. 7.15 Turret Terminal*

### Desoldering

In order to replace a component part, it is often necessary to remove the old part by means of de-soldering. Several methods are available, the most common being the braided bare copper method. This wire is placed on the lead(s) of the component to be removed with the iron placed on top of the braided wire. This allows the solder to heat up while simultaneously adhering to the braid. When the braided wire is removed, the joint should be clean. (See Fig. 7.16)



*Fig. 7.16 Wire Braid Desoldering*

Next, use points of small diagonals to lift ends of component lead wires and remove the part. This procedure is applicable to both PC board desoldering as well as terminal and lug desoldering.

**Note:** Be sure that lifting of the component lead does not also lift the copper foil pad from the board. Occasionally a small amount of heat will be helpful.

Soldering is one of the most reliable methods of joining electronic component parts and assemblies. When properly used, it can be one of the most helpful tools in service repair work.

## 7.4 Basic Troubleshooting

As is well known, time is an important factor in providing efficient service repair. Therefore, several time-saving troubleshooting steps are listed below. These hints may or may not already be implemented in your service work. If not, you may wish to experiment with them in order to help improve your efficiency. After all, time is money!

### A. Establishing Problems

User complaints about defective operation may not always be clear or simple. Furthermore, the trouble the user has experienced may be due to the system and not the unit itself. If possible talk to the user about his problem. This will usually be simpler than trying to understand written complaints. A first hand account of the problem can help in:

- 1) Getting the problem to re-occur on the service bench.
- 2) Getting an understanding of the probable cause. Some troubles will be obvious upon visual inspection. When the trouble (or its symptoms) is not so obvious ask:

- a) Exactly what was the problem; how was it noticeable?
- b) How was the unit being used?
- c) Has the system as a whole been carefully examined for possible external problems?
- d) How long had the unit been operating when the problem occurred? Was it heat related?

If the user is unavailable or unable to explain the trouble the next step is a thorough visual inspection.

### B. Visual Inspection

A good visual inspection may often save hours of tedious troubleshooting. Make a habit of proceeding in an orderly manner to insure that no vital part of the

following procedure is omitted. The visual inspection can be performed in 10 to 15 minutes. It is recommended both as a preventive maintenance procedure and also for its value in determining cause of malfunction.

- 1) Check that all external screws are tight and that none are missing.
- 2) Check all fuses/circuit breakers.
- 3) Check for smooth and proper operation of switches, etc.
- 4) Inspect line cord for possible damage to cap, jacket and conductors.
- 5) Remove protective covers as outlined in disassembly instruction (Section 7.6).
- 6) Check that all attaching parts for internal circuits are tight and that none are missing.
- 7) Inspect all wiring for charred insulation, or discoloration as evidence of previous overheating.
- 8) Check that all electrical connections are secure. This includes wire terminals, screw and stud type terminals, and all soldered connections.
- 9) Check for obvious destruction of internal structural parts. Distortion in any of these parts could mean that the unit has been dropped or subjected to severe shock.

## 7.5 Discharging Instructions

The D-150A amplifier employs very large-storage capacitors in the main power supply (C2, C3). For this reason, at any time the covers are removed it is necessary to discharge these large capacitors in order to avoid possible damage to the unit and also to prevent shock hazard. This is best performed by placing a 50 ohm/10 watt resistor across capacitor terminals shown in Fig. 7.17. Always use extreme caution while handling the discharge device.

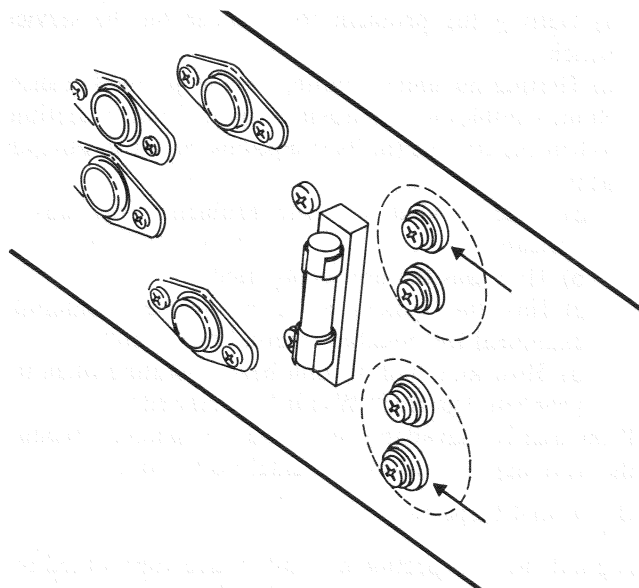


Fig. 7.17 D-150A Discharge Points

## 7.6 Disassembly for Inspection, Service, Testing, Adjustment and Repair

The extent of disassembly required will depend upon the extent of inspection, service, testing, adjustment and repair to be performed. Illustrations referred to in parenthesis (index numbers) are located in the parts list (Section 6) of this manual.

The D-150A amplifier is specifically designed for easy servicing. It may be partially disassembled and still be made operational for bench testing and servicing. This may be accomplished by removing the front panel, transformer cover and wrap-around, and the board electronics cover (Section A).

These steps provide easy access to nearly all major components of the amplifier. Those that are not now accessible for servicing can be removed following the procedures given for replacing individual assemblies.

**Caution: DO NOT attempt component replacement or other repairs with power applied. Always follow discharging instructions (Section 7.5) to prevent possible circuit damage or serious shock.**

### A. Removal of Front Panel, Transformer Cover and Wrap-Around, and Board Electronics Cover

1. Remove four socket head screws (7), two from each end of the rack ears (6), and remove the six phillips front panel mounting screws (30).
3. Remove two screws (15) from the top of the transformer cover (14), and remove the transformer cover and the transformer wrap-around (13).
4. Remove two screws (33) from the top of the board electronics cover (17) and remove the cover.
5. Reverse the above sequence of actions to reassemble the amplifier covers.

### B. Removal of Control Plate Assembly

1. Remove board electronics cover (17) as described in paragraph A, Step 4.
2. Remove two screws (42) from top of control plate assembly.
3. Carefully lift control plate assembly and turn nearest edge (where screws were removed) upward until bottom of control plate is accessible. Do not place unnecessary strain on wiring connected to main PC board.
4. Input jacks (39) are now accessible for replacement.

### C. Replacement of Components on Main PC Board

1. Remove board electronics cover (paragraph A, Step 4). Both component and solder sides of board are now accessible.
2. Carefully unsolder and replace (with identical parts) any defective components.





**Caution: Use normal soldering precautions. DO NOT use excessive heat; heatsink adjacent components to prevent damage.**

3. The IC is a plug-in component.
  4. Resistors R128, R228 (selected bias resistors) are plug-in components.
- D. Replacement of Input Level Potentiometers (R105, R205)
1. Remove board electronics cover, paragraph A, Step 4.
  2. Remove front panel, paragraph A, Step 2.
  3. Unsolder and tag for identification all leads to the terminals of input level potentiometer (27).
  4. Remove control nut (2) using a 1/4" nut driver and remove defective R105 and R205 from the front panel (5).
  5. Solder leads removed in Step 3 to terminals of new input level potentiometer (27).
  6. Place new potentiometer in position and replace control nut (2).
  7. Replace the front panel.
  8. Replace board electronics cover, paragraph A.
- E. Replacement of Thermal Switch, SW-1
1. Remove front panel (paragraph A, Step 2).
  2. Remove board electronics cover (paragraph A, Step 2).
  2. Remove board electronics cover (paragraph A, Step 4).
  3. Disconnect two Faston connectors from terminals of thermal switch SW-1.
  4. Remove two each, screws (51), hex nuts (45), star washers (46), solder lugs (50) and remove thermal switch SW-1 from the chassis.
  5. Place new thermal switch SW-1 (49) in position and replace hardware removed in Step 4.
  6. Reconnect two Faston connectors to terminals of new thermal switch SW-1.
  7. Replace board electronics cover (paragraph A, Step 4).
  8. Replace front panel (paragraph A, Step 2).
- F. Replacement of Bridge, DM-1
1. Remove transformer cover and transformer wrap-around (paragraph A, Step 3).
  2. Remove front panel (paragraph A, step 2).
  3. Disconnect four Faston connectors from terminals of bridge DM-1 (66).
  6. Reconnect four Faston connectors to terminals of bridge DM-1.
  7. Replace front panel (paragraph A, Step 2).
  8. Replace transformer cover and transformer wrap-around (paragraph A, Step 3).
- G. Replacement of Filter Capacitors, C2 and C3
1. Remove front panel (paragraph A, Step 2).
  2. Remove transformer cover and transformer wrap-around (paragraph A, Step 3).
  3. Remove one Faston connector from filter capacitor (C2 or C3) terminal.
  4. Remove two screws, (60), one solder lug (62), two panel washers (65) and two fiber shoulder washers (64) from the filter capacitor terminals.
  5. Remove defective filter capacitor (C2 or C3) from the chassis.
  6. Place new filter capacitor in position and replace hardware removed in Step 4.
  7. Reconnect Faston connector to filter capacitor terminals.
  8. Replace transformer cover and transformer wrap-around (paragraph A, Step 3).
  9. Replace front panel (paragraph A, Step 2).
- H. Replacement of Output Inductors, L101 and L201
1. Remove front panel (paragraph A, Step 2).
  2. Remove board electronics cover (paragraph A, Step 4).
  3. Unsolder one end of brown coil wire from the output binding post terminal and the other end from the adjacent driver transistor terminal.
  4. Remove hex nut (52), nylon washer (53) output coil toroid core and brown wire (54).
  5. Place new output coil toroid core and new brown wire in position and replace hardware removed in Step 4.
  6. Solder one end of brown coil wire to the output binding post terminal (55) and the other end to the adjacent driver transistor terminal.
  7. Replace board electronics cover (paragraph A, Step 4).
  8. Replace front panel (paragraph A, Step 2).

## I. Replacement of Driver and Output Transistors

1. Remove front panel (paragraph A, Step 2).
2. Remove board electronics cover (paragraph A, Step 4).
3. Unsolder and tag for identification all wires and component leads connected to transistor terminals. DO NOT unsolder leads attached to solder lugs mounted on transistors.
4. Refer to detail drawings of output and driver transistor and remove hardware shown and the defective transistor.
5. Coat both sides of the insulator (86, 91) between the transistor case and the chassis with a heat-conducting compound (Z5 silicon compound).
6. Install new transistor and tighten screws and hex nuts snugly to assure good heatsinking.
7. Resolder wires and component leads removed from transistor terminals in Step 3 above.
8. Replace board electronics cover (paragraph A, Step 4).
9. Replace front panel (paragraph A, Step 2).

## J. Replacement of Power Transformer, T-1

1. Remove front panel (paragraph A, Step 2).
2. Remove transformer cover (14) and transformer wrap-around (13) (paragraph A, Step 3).
3. Disconnect seven transformer wires that pass through the hole in the chassis beside the transformer base.
  - a. Two red wires; remove Faston connectors from DMI terminals and remove Faston connectors from the red wires.
  - b. One yellow wire; unsolder from solder lug (62) at junction of capacitors C2 and C3.
  - c. One black and one white wire; unsolder from terminal strip (68).
  - d. One black/red wire and one black/white wire; unsolder from terminal strip (68).

4. Pull all wires back through hole in chassis.
5. Remove hardware securing transformer T1 to the chassis:
  - a. Remove four hex nuts (70).
  - b. Remove four star washers (71).
  - c. Remove pilot light assembly (73, 74).
  - d. Remove terminal strip (68).
  - e. Remove rubber grommets (81).
  - f. Remove four transformer mounting screws (72).
6. Remove defective transformer T1 (75).
7. Cut leads on new transformer T1 to same length as those on the transformer being replaced.
8. Place new transformer T1 in position on the chassis and replace, in reverse order, all item removed in Step 5.
9. Pull all transformer wires through chassis hole to bottom side of chassis.
10. Connect seven transformer wires to destinations shown in Step 3 (also see Section 7.10).
11. Replace transformer cover and transformer wrap-around (paragraph A, Step 3).
12. Replace front panel (paragraph A, Step 2).

## 7.7 Reassembly

Reassembly is essentially the reverse of disassembly. If in doubt about types and sizes of attaching parts, refer to the appropriate illustration in Section 6.

## 7.8 Electrical Checkout and Adjustment Procedures

The following chart outlines an orderly checkout and adjustment procedure for the D-150A. The test equipment required to perform the various procedures is listed in Section 7.2.

Type of Test/Adjustment	Input Signal Characteristics
1. Quiescent DC offset	None
2. Bias Adjustment	None
3. Power Test (one channel driven)	1 volt; 1 KHz sine wave

### Comments

A. DC millivolt meter is connected to amplifier output. Input level controls are fully counterclockwise while offset controls (R105, R205) are adjusted for zero volts at output.

B. Input level controls are at twelve o'clock (or adjusted for maximum DC offset). Offset controls (R103, R203) are adjusted for zero volts at output.

Positive output, base-emitter junction should be between .3V and .35V. It is altered by selected resistors R128, R228; they are typically between 92 and 240 ohms.

Into 8 ohms, 28Vrms (98 watts) should be obtainable before signal clip. Into 4 ohms, 26.5 Vrms (175 watts) should be obtainable before signal clip.

- |    |                            |  |   |
|----|----------------------------|--|---|
| 4. | Protection Circuitry       | 1 volt; 1KHz<br>sine wave                                    | Into 2 ohms, 39Vrms should be obtainable before signal clip without a load.   |
| 5. | High Frequency             | 1 volt; 10KHz<br>square wave<br>1 volt; 20KHz<br>sine wave   | Into an 8 ohm load, a 30 volt peak-peak square wave signal should exhibit no ringing.<br>Into an 8 ohm load, a 27Vrms signal should exhibit no ringing.   |
| 6. | Intermodulation Distortion | .5V $\pm$ 2%; 60Hz-<br>7KHz signal<br>summed in 4:1<br>ratio | (See Fig. 7.18) When using the Crown IMA, typical readings will be as follows:<br>0dB = .004% (20 volts out)<br>through -25dB = .01%<br>through -40dB = .03%<br><b>Note:</b> All distortion readings <b>must</b> be below .01%. |
| 7. | IOC                        | 2.5V peak-peak<br>.5Hz square wave                           | IOC lights should illuminate once for every rise time and once for every fall time (twice every full cycle). Test generator rise time must be less than 1.0 microsecond.  |
| 8. | Signal to Noise            |  | (See Fig. 7.19) Signal to Noise should be 115dB below rated output with meter bandwidth of 20Hz to 20KHz.   |
| 9. | Quiescent AC Power         |  | 30 watts at idle as monitored by wattmeter on AC line;<br>250 watts full rated output.  |

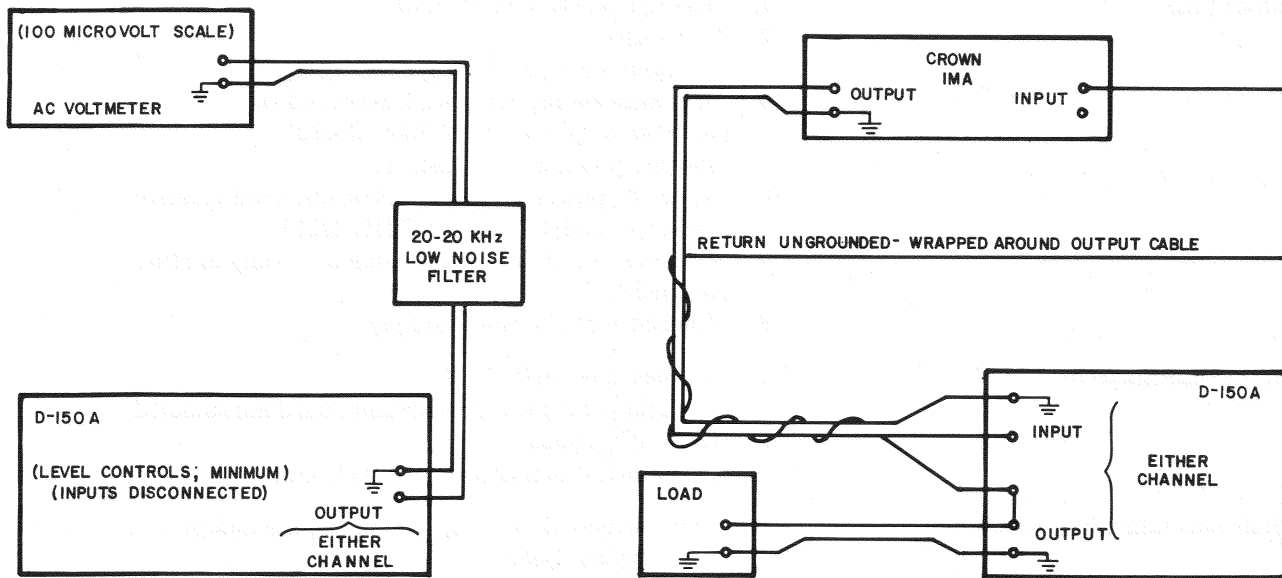


Fig. 7.18 IM Distortion Test Set-up

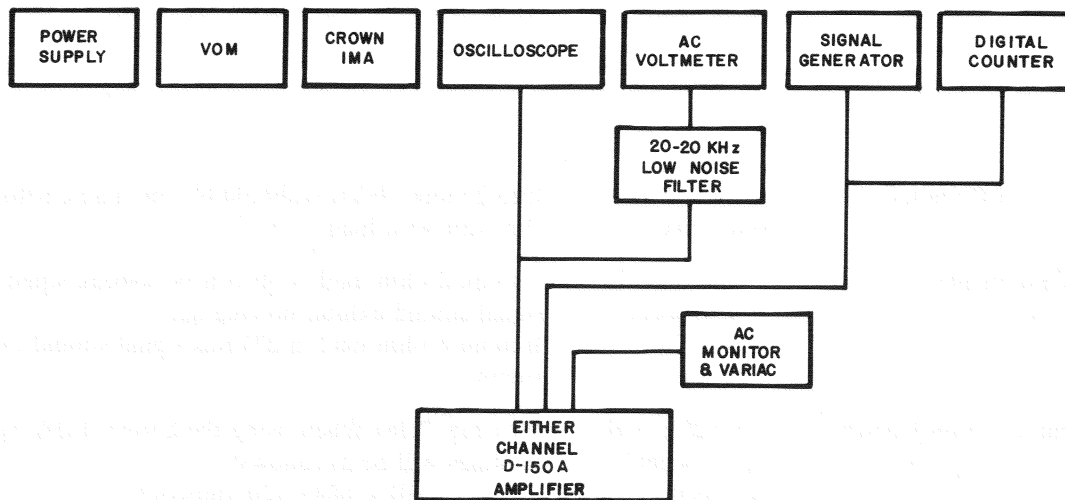


Fig. 7.19 Signal to Noise Test Set-up

## 7.9 Troubleshooting Hints

### Symptom

### Defect

Blows Fuse

1. Rectifier block shorted, DM 1
2. C1 shorted
3. Leaky or shorted filter capacitors C2, C3
4. Bootstrap supply AC wire frayed and shorts to positive supply trace on Main Board
5. Shorted power transformer T1
6. A shorted power device in both positive and negative output stage Q110, Q114, Q210, Q214
7. Fuse blown due to external problem - wrong size fuse inserted
8. Pinched wires in power supply

No Output Stage Bias

1. No bias resistor R128, R228
2. Bias resistor connector to circuit board not soldered
3. L100, L200 open
4. C-E short of bias transistor Q111, Q211

High Bias (amplifier heats up)

1. Amplifier instability-high frequency oscillation (check Q106, Q206)
2. Shorted output terminal post
3. DC offset (see offset section)
4. Leaky output device (may pass signal and show okay with continuity test) Q110, Q114, Q210, Q214



Symptom	Defect
Negative Offset -Both Channels-	<ol style="list-style-type: none"> <li>1. Defective IC op amp (UA739)</li> <li>2. D5 shorted</li> <li>3. Q101, Q201 leaky or shorted</li> </ol>
Positive Offset -Both Channels-	<ol style="list-style-type: none"> <li>1. Defective IC op amp (UA739)</li> <li>2. D4 shorted</li> </ol>
Positive Offset -Single Channel-	<ol style="list-style-type: none"> <li>1. Defective IC op amp (UA739)</li> <li>2. Q100, Q200 leaky or shorted</li> <li>3. Q101, Q201 open</li> <li>4. Q106, Q206 open, leaky or shorted</li> <li>5. Q105, Q205 open leaky or shorted</li> <li>6. Positive predriver, driver or output device leaky or shorted Q107, Q207, Q109, Q209, Q110, Q210</li> <li>7. Q111, Q211 shorted</li> </ol>
Negative Offset -Single Channel-	<ol style="list-style-type: none"> <li>1. Defective IC op amp (UA739)</li> <li>2. Mono switch hot wire shorted to ground</li> <li>3. Negative predriver, driver or output device leaky or shorted Q112, Q212, Q113, Q213, Q114, Q214</li> <li>4. Q101, Q201 base to collector leakage</li> </ol>
Small DC Offsets	<ol style="list-style-type: none"> <li>1. Broken ground on input level control (R105, R205)</li> <li>2. Input jack hot lead and ground pin not shorted together (level controls full up with no input jack)</li> <li>3. D100, D200 leaky or shorted</li> </ol>
Negative half of Signal missing	<ol style="list-style-type: none"> <li>1. Q112, Q212 open</li> <li>2. Violet/white wire from main board to output board open or not soldered</li> </ol>
Positive half of Signal missing	<ol style="list-style-type: none"> <li>1. Bootstrap supply               <ol style="list-style-type: none"> <li>a. C4 open</li> <li>b. D1 or D2 shorted</li> <li>c. Green AC wire not soldered correctly</li> </ol> </li> <li>2. Q101, Q202 open</li> <li>3. Loss of positive supply voltage (+45V)</li> <li>4. D3 shorted</li> <li>5. Q108, Q208 open, leaky or shorted</li> <li>6. Q107, Q207 open</li> <li>7. R132, R232 open</li> <li>8. Yellow/white wire from main board to output board open or not correctly soldered</li> </ol>
Oscillation (Full waveform)	<ol style="list-style-type: none"> <li>1. R106, R206 open</li> <li>2. C116, C216 open</li> </ol>
Oscillation (Positive half)	<ol style="list-style-type: none"> <li>1. Defective IC op amp (UA739)</li> <li>2. Defective driver, Q109, Q209</li> <li>4. C113, C213 open</li> </ol>

Symptom	Defect
Oscillation (Negative half)	<ol style="list-style-type: none"> <li>1. Defective IC op amp (UA739)</li> <li>2. C112, C212 defective</li> <li>3. Defective driver, Q113, Q213</li> </ol>
Protection Circuit - No current limiting	<ol style="list-style-type: none"> <li>1. Current limiting transistor open <ol style="list-style-type: none"> <li>a. Positive (Q103, Q203)</li> <li>b. negative (Q104, Q204)</li> </ol> </li> <li>2. D101, D107, D201, D207 open</li> <li>3. R119, R118, R219, R218 open</li> <li>4. C108, C109, C208, C209 open</li> </ol>
-Excessive limiting	<ol style="list-style-type: none"> <li>1. D101, D107, D201, D207 shorted</li> <li>2. Q104, Q103, Q204, Q203 shorted</li> <li>3. Loose output hardware</li> </ol>
-Current limiting oscillation-	<ol style="list-style-type: none"> <li>1. Negative feedback capacitor, in limiting transistor circuit defective, positive C107, C207, negative C110, C210</li> </ol>
-Flyback pulses from inductive loads -	<ol style="list-style-type: none"> <li>1. C108, C109, C208, C209 open</li> </ol>
Clipping (negative) Both Channels	<ol style="list-style-type: none"> <li>1. D5 leaky or open</li> <li>2. Q2 leaky or open</li> <li>3. Defective IC op amp (UA739)</li> </ol>
Clipping (positive) Both Channels	<ol style="list-style-type: none"> <li>1. D4 open or leaky</li> <li>2. D3 open or leaky</li> <li>3. Defective IC op amp (UA739)</li> <li>4. D1 or D2 open (positive portion of signal will clip at a 60Hz rate)</li> <li>5. C4 open or changed in value</li> </ol>
Clipping (positive) Single Channel	<ol style="list-style-type: none"> <li>1. Open or leaky predriver, Q107, Q207</li> <li>2. Shorted or leaky limiting transistor Q103, Q203</li> <li>3. Open output emitter resistor R132, R232</li> <li>4. Defective IC op amp (UA739)</li> <li>5. Q102, Q202 defective</li> </ol>
Clipping (negative) Single Channel	<ol style="list-style-type: none"> <li>1. Open or leaky predriver Q112, Q212</li> <li>2. Shorted or leaky limiting transistor Q104, Q204</li> <li>3. L100, L200 open</li> <li>4. Open output emitter resistor R134, R234</li> <li>5. Q115, Q116, Q215, Q216 on IOC board defective</li> </ol>
High IM (Load Related)	<ol style="list-style-type: none"> <li>1. R9 (1 ohm) open</li> <li>2. Defective IC op amp (UA739)</li> <li>3. C101, C201 open</li> <li>4. C114, C214 open</li> <li>5. Q106, Q206 defective</li> <li>6. Defective predriver or driver device Q107, Q207, Q112, Q212, Q109, Q209, Q113, Q213</li> </ol>
Low dB IM	<ol style="list-style-type: none"> <li>1. Low output Bias</li> <li>2. C102, C202 open</li> <li>3. C104, C204 open</li> </ol>



**Symptom**

**Defect**

High IM (Not Load Related)

1. R115, R215 changed in value
2. R109, R209 changed in value
3. C105, C205 changed in value
4. C106, C206 changed in value

120Hz in output waveform

1. Power Supply filter capacitor(s) open, C2, C3
2. C5 open
3. Power Supply filter capacitor mounting hardware loose

High noise

1. Input jacks not isolated from chassis ground
2. Noisy zener diode, D3
3. Broken ground on input jack, in input cable or on input level control (R105, R205)
4. Oscillation (C101, C201 open)

**7.10 Voltage Conversion Instructions**

Often Crown products are purchased in one country and later transported to another requiring an AC mains conversion. For this reason the following chart/explanation as well as a world-wide voltage map (in the rear of this manual) is provided.

The D-150A power supply may be connected for any of five voltages. Converting from one to another can be accomplished with a soldering iron and a pair of wire strippers. Observe the following instructions:

1. Remove the two rack ears from the front panel.
2. Remove the front panel/ bottom cover (See Section 7.6A).
3. Position the front panel to gain access to the transformer leads. Locate the two terminal strips (terminals A,B,C, D and E).
4. Determine the correct connection from Fig. 7.20 and solder the leads accordingly.
5. For all connections 200VAC and above, the line fuse F1 is changed from 6.25 amps to 3 amps.
6. Carefully check all connections, then repeat steps 1 and 2 in reverse.

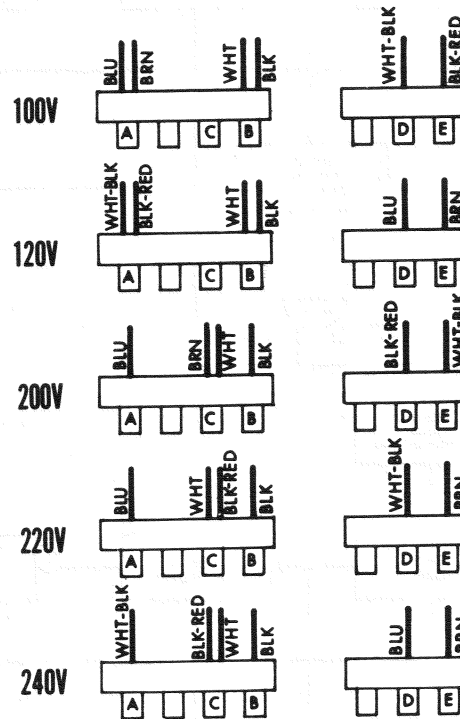


Fig. 7.20 Voltage Conversion

## 7.11 Block Diagram Circuit Theory

The following discussion refers to the block diagram in Fig. 7.21.

The input amplifier is the initial stage of circuitry that establishes the fixed gain of the D-150A. The input bias compensation stage, directly related to the input stage, helps control any DC drift that may occur with a unique temperature-controlled circuit.

The IOC (Input Output Comparator) circuitry works in conjunction with the error correcting signal of the main op amp. Any time a small "non-linearity" exists in the amplifier, an error signal appears at the output of the main op amp (via the feedback loop of the unit). This produces an abnormally high value, exceeding the "window" of the IOC and illuminating the LED. Since transient overload can happen rapidly, a pulse stretching circuit is added so the eye can detect the LED lighting.

The signal translator stage combined with the last voltage amp form the voltage amplification stages of the D-150A. Virtually no voltage amplification is performed beyond these stages.

Current amplification circuitry consists of basically three stages: the Predriver, the Driver and the output transistor stage. Connected to these stages, is the protection circuitry which is activated when a predetermined amount of voltage and/or current is drawn across the output stage sense resistors. This protection signal is then in turn fed back to the limiting circuit which limits any increase in the bias servo voltage to the power devices.

The power supply is a continuous-duty type. The main DC supplies are full-wave capacitor input type with heavy duty, chassis heat-sinked diodes. The input amplifiers are powered by zener-regulated power supplies. The bias regulators are also powered by zener-regulated current sources with the result that line voltage variations do not cause noise or distortion due to mis-biasing.

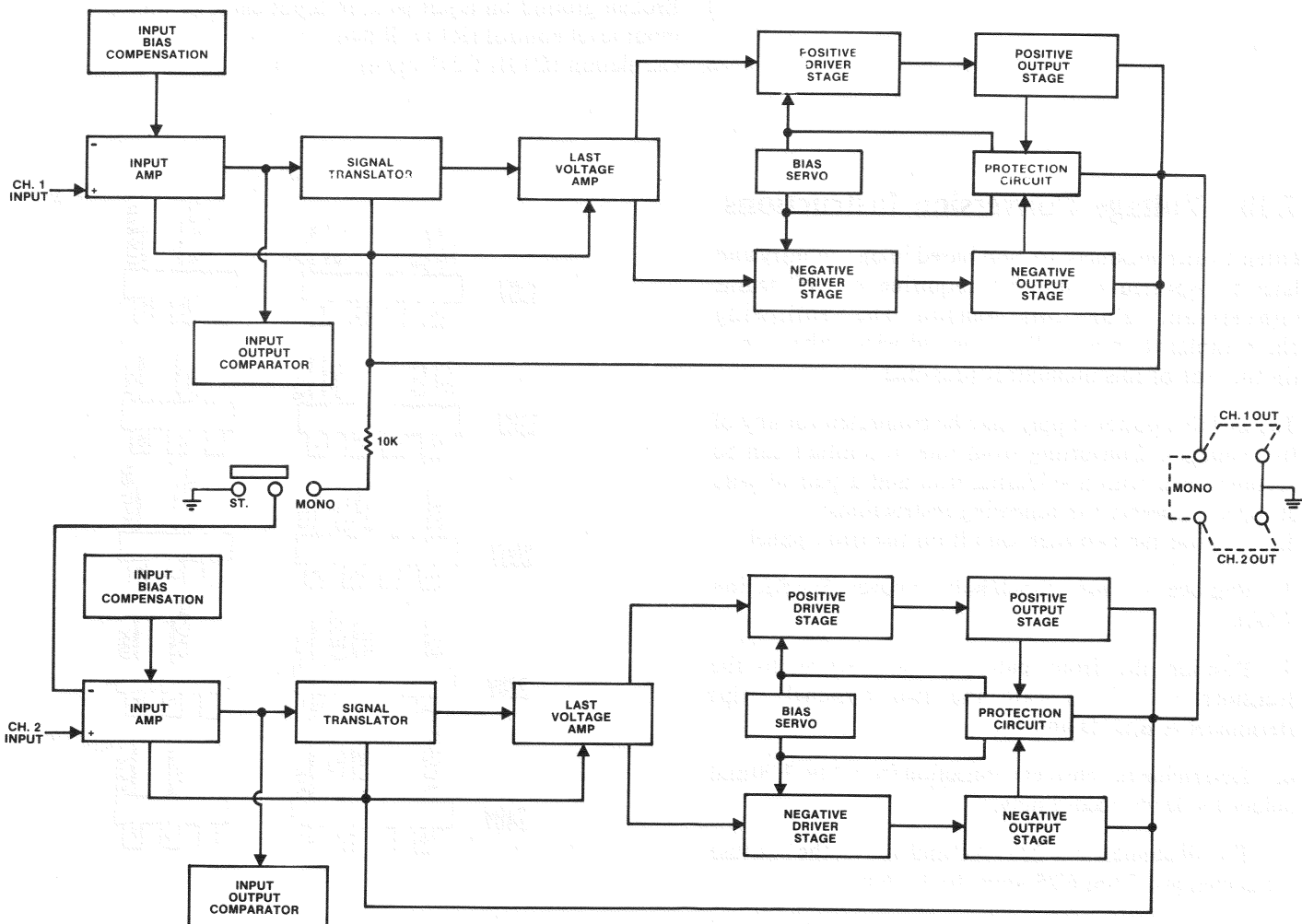


Fig. 7.21 D-150A Block Diagram



## 7.12 Theory of Operation

The following explanation refers to schematic diagram MI-261E located in Section 6. However, each circuit under discussion is reprinted below in order to aid in circuit familiarization. Only channel 1 is shown for simplicity.

### A. Input Stage

After entering the unbalanced 1/4" input jack, the input signal level is adjusted to a desired input amplitude through R105 and then applied to the dual IC operational amplifier (IC1A, IC1B). This op amp is a low noise, large gain bandwidth type which results in usage of feedback circuit loops throughout and ultimately, extremely low distortion values. The direct input signal is applied to the non inverting input (pin 5) of IC1A and the feedback signal is applied to the inverting input (pin 6).

Both signals entering IC1A will be in phase with each other because of the feedback path and will thus produce an output (pin 1) of almost zero. The IC op amp will always try to keep a zero potential difference between both inputs. Any type of non-linearity will cause the op amp to produce a large output, and therefore a substantial size correction signal in order to retain the small output level.

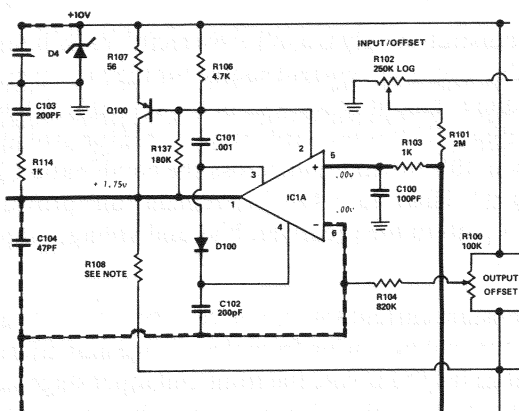


Fig. 7.22 Input Stage

### B. Voltage Amplification

The operation of the D-150A front-end circuitry (IC op amp through Q105) is to basically provide voltage amplification. However, the signal translator transistor (Q101) provides no voltage amplification itself, but rather converts the ground referenced input signal to a signal with a reference to the negative supply (-45V). The result is higher voltage swing capabilities from Q105 (final voltage amplifier).

The final voltage amplification transistor (Q105) is the main source of voltage amplification in the D-150A. R116 in the base circuit of this transistor serves two purposes:

01

- 1) it provides collector current for Q101
- 2) it allows the signal on the collector of Q101 to be developed across it and thus amplified.

As this development is in process, Q105 emitter voltage is developed across R124. When this voltage reaches a positive .6V, Q106 turns on and "pulls" the drive away from the last voltage amplifier, thus acting as a current limiter for Q105.

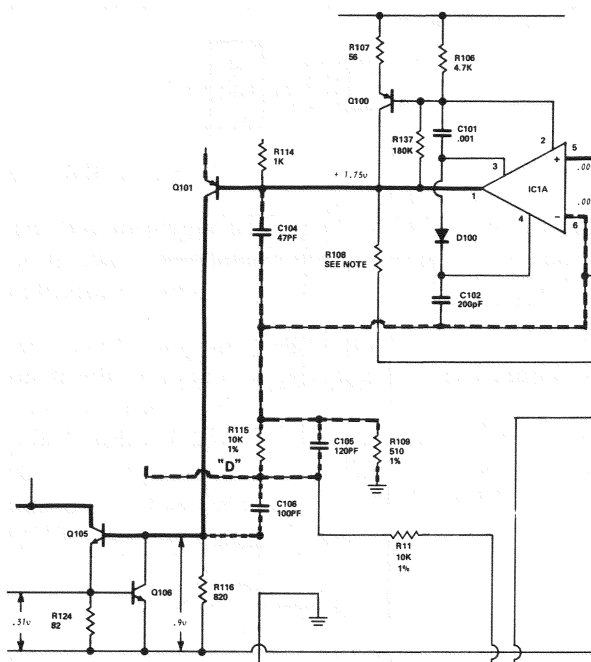


Fig. 7.23 Voltage Amplification Stage

Handwritten text in the top left corner, possibly a date or reference number.



Main body of handwritten text on the left page, consisting of several paragraphs.

Bottom section of handwritten text on the left page, possibly a signature or concluding remarks.

Handwritten text in the top right section of the page, appearing as a separate entry or note.

Middle section of handwritten text on the right page, continuing the main body of text.

Bottom section of handwritten text on the right page, possibly a signature or concluding remarks.

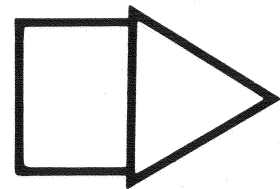


## **SECTION 8**

# **SERVICE BULLETINS**

Periodically, a situation may arise where Crown will feel that it is necessary to change or update specific circuitry by the addition or subtraction of component parts. This information is automatically sent to all Crown Warranty Service Stations. It should be kept with this manual, preferably behind this page as indicated by the note at bottom. Should there be any question pertaining to these changes or updates, call or write the Crown Technical Service Department.

**PLACE ALL  
SERVICE UPDATES  
HERE**





SECTION 1

REVENUE DEPARTMENT

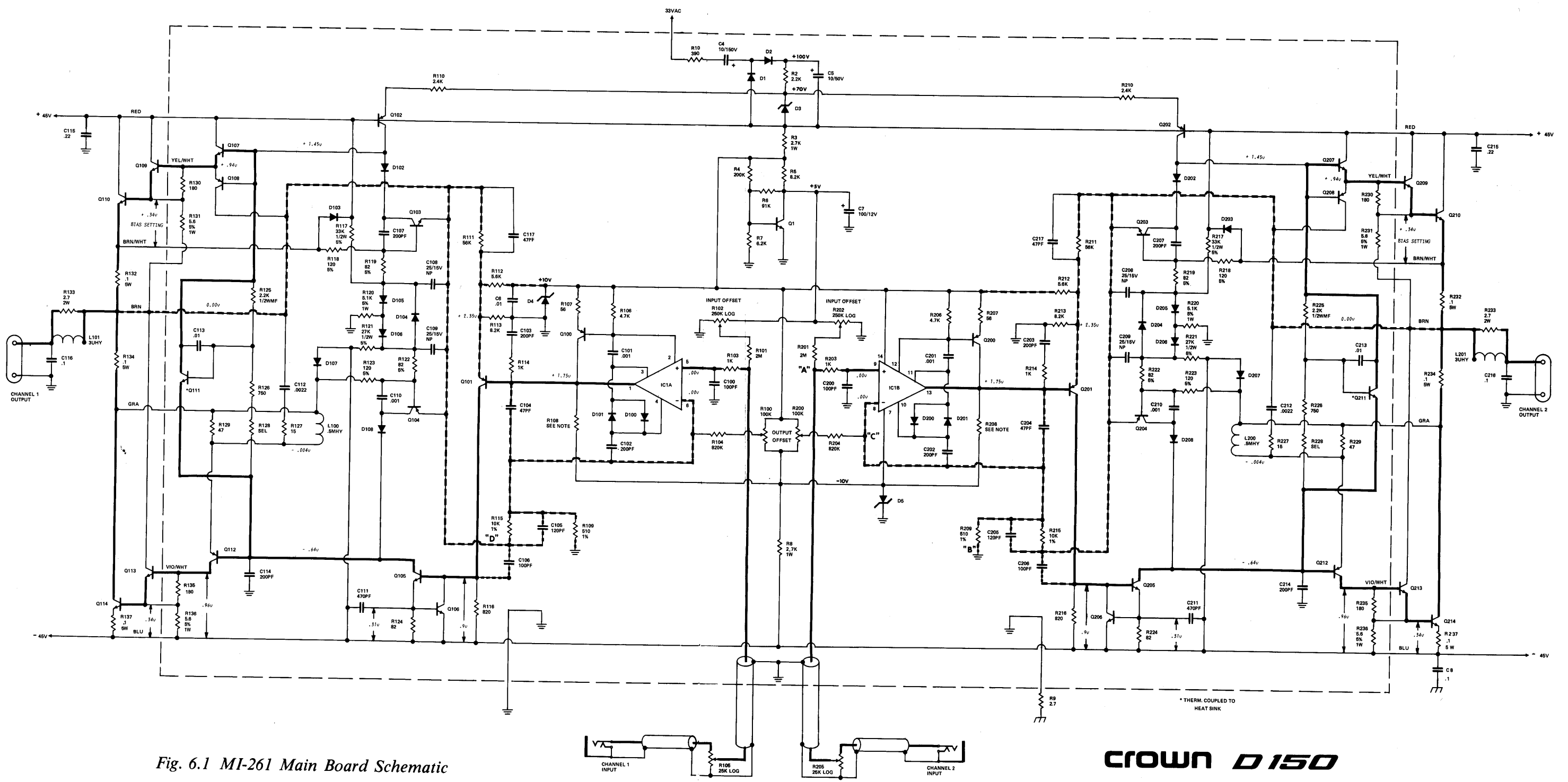
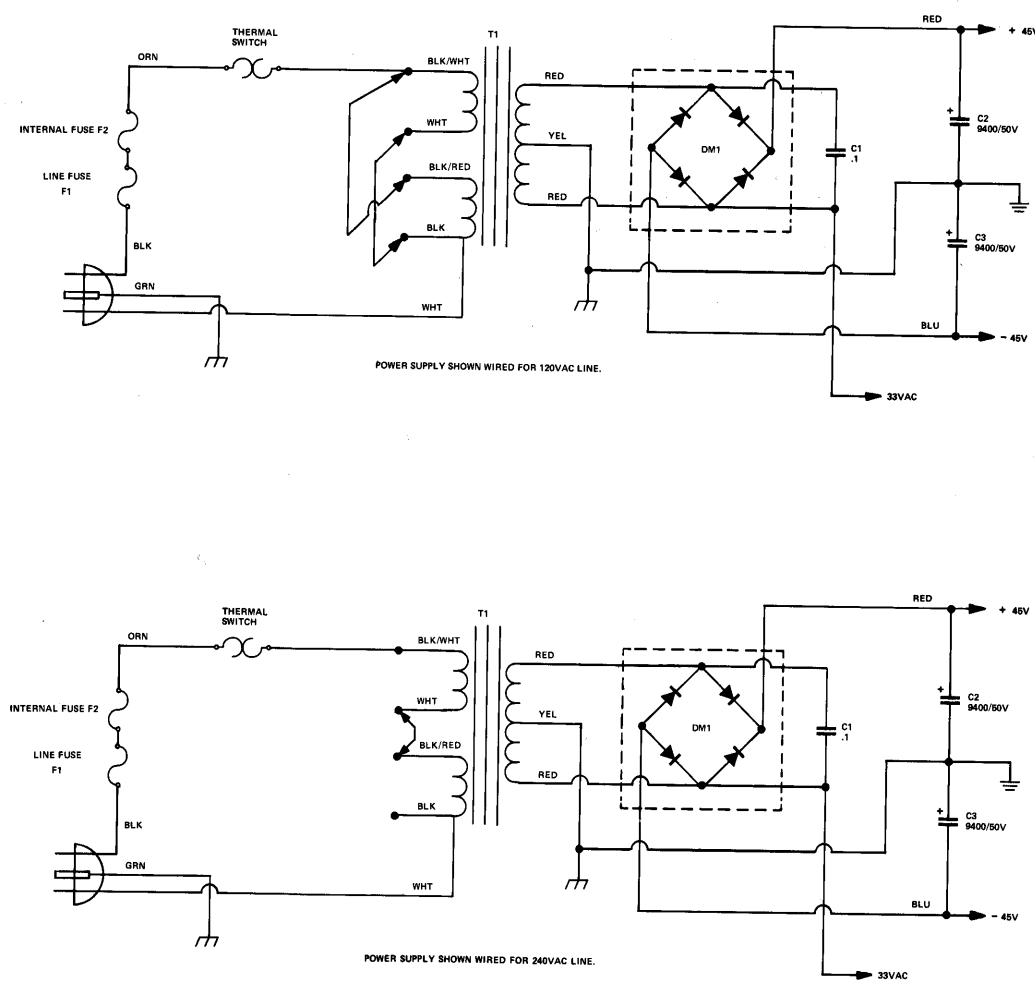
The following information is provided for your information and is not intended to constitute an offer of any financial product or service. It is provided for informational purposes only and should not be relied upon as a basis for any investment decision. The information is provided for informational purposes only and should not be relied upon as a basis for any investment decision.

SECTION 2

REVENUE DEPARTMENT

SECTION 3





- NOTES:**
- THIS SCHEMATIC APPLIES TO AMPLIFIERS NUMBERED SN8359 TO SN17875 (SELECTED UNITS).
  - DC VOLTAGES ARE SHOWN FOR VARIOUS POINTS. THESE ARE THE NORMAL OPERATING VOLTAGES FOR ZERO INPUT.
  - THE HEAVY CONTINUOUS TRACE FOLLOWS THE PRIMARY SIGNAL PATH THROUGH THE CIRCUIT. THE HEAVY BROKEN TRACE SHOWS FEEDBACK PATHS.
  - WIRE COLOR CODES ARE GIVEN FOR THE MAIN POWER SUPPLY AND SOME BOARD WIRES.
  - ALL RESISTORS IN OHMS UNLESS OTHERWISE STATED.
  - ALL CAPACITORS IN MICRO-FARADS UNLESS OTHERWISE STATED.
  - COMPONENTS COMMON TO BOTH CHANNELS ARE NUMBERED FROM 1 TO 99.
  - CHANNEL ONE COMPONENTS ARE NUMBERED FROM 100 TO 199.
  - CHANNEL TWO COMPONENTS ARE NUMBERED FROM 200 TO 299.
  - FOR MONO CONVERSION TIE POINT A TO B AND C TO D.
  - R108 AND R208 SHOULD BE 3.3K, 1/4W WHEN IC1 IS NA749.

Fig. 6.1 MI-261 Main Board Schematic

**CROWN D150**  
 Laboratory Power Amplifier  
 MI 261  
 NPC OUTPUTS

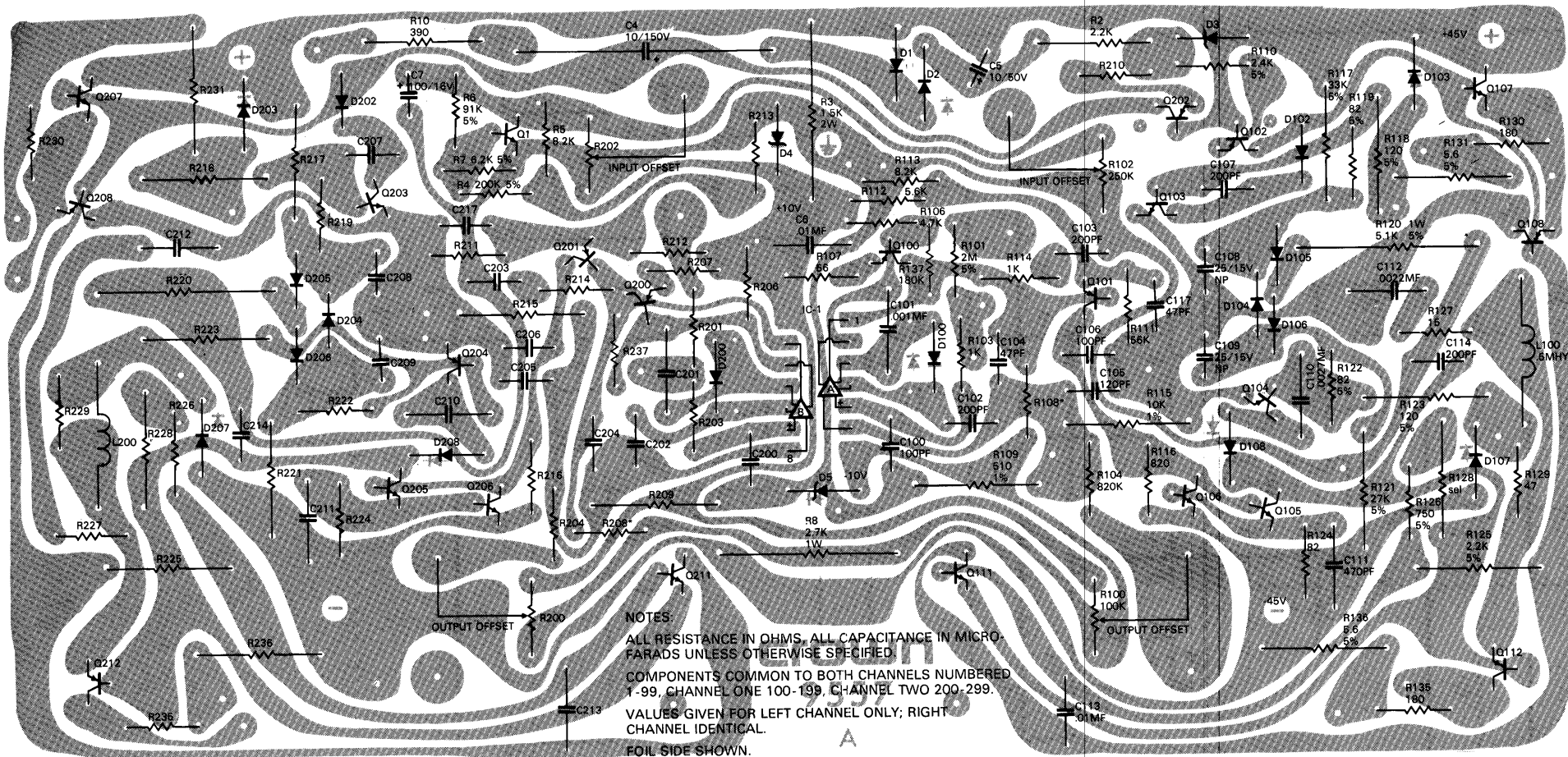


Fig. 6.2 MI-261 Foil Board Layout

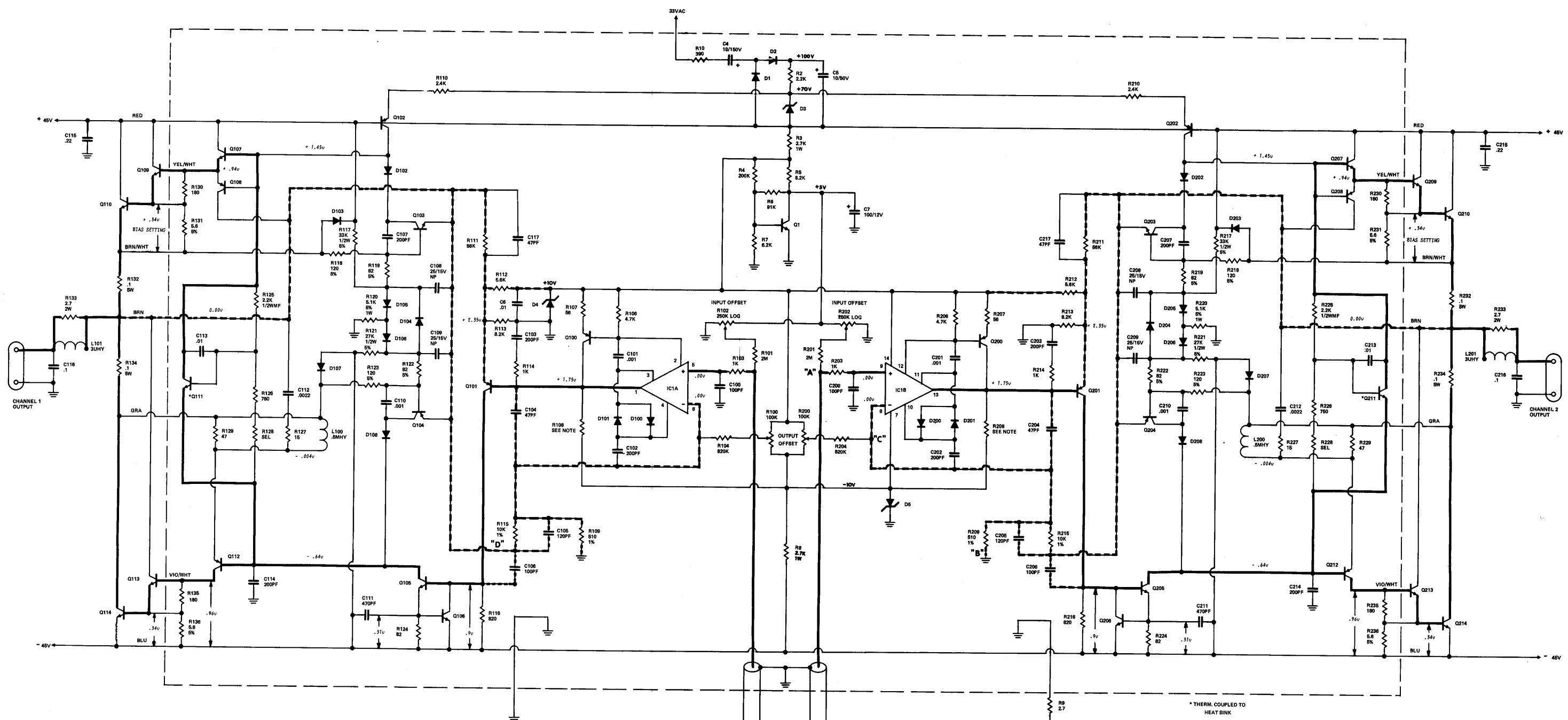
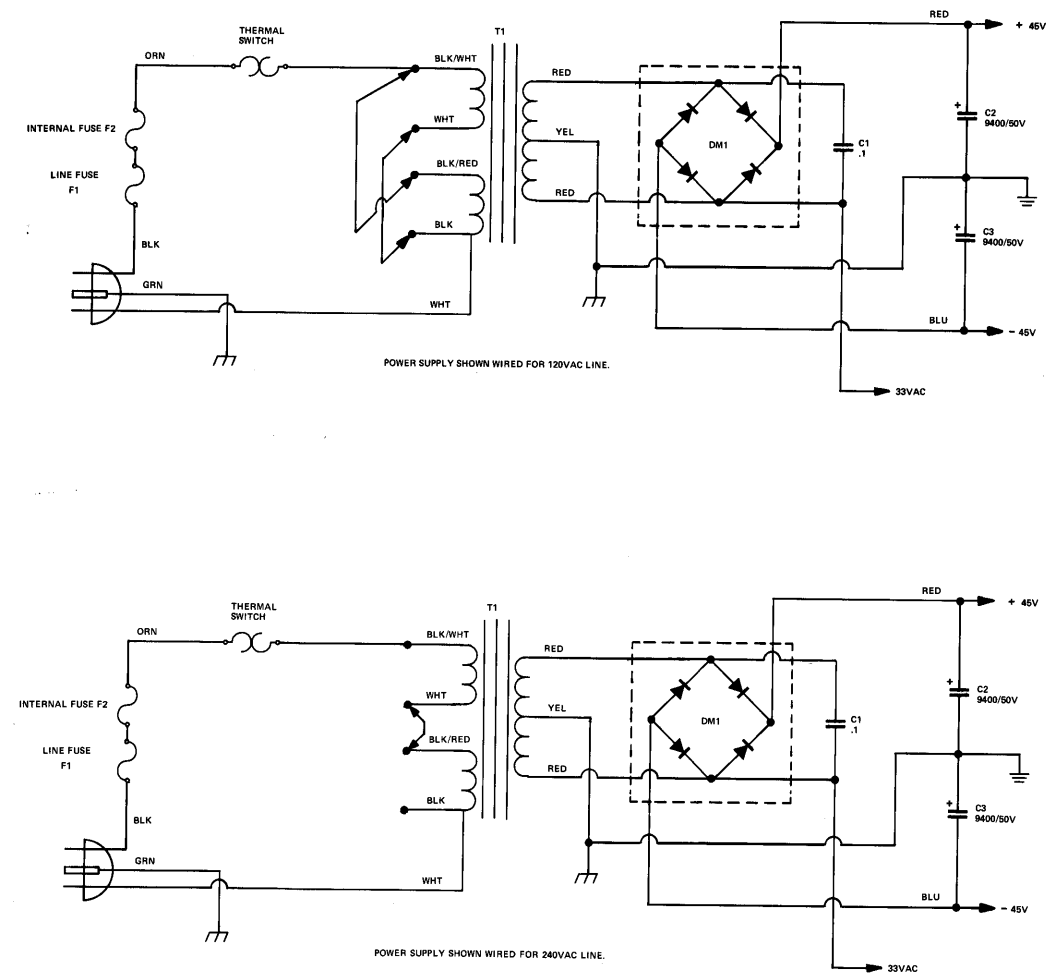
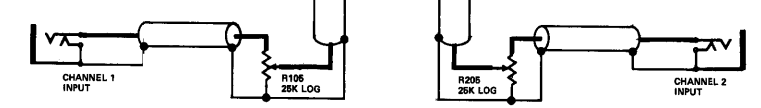


Fig. 6.3 MI-261A Main Board Schematic

- NOTES:**
- THIS SCHEMATIC APPLIES TO AMPLIFIERS NUMBERED SN8359 TO SN17875 (SELECTED UNITS).
  - DC VOLTAGES ARE SHOWN FOR VARIOUS POINTS. THESE ARE THE NORMAL OPERATING VOLTAGES FOR ZERO INPUT.
  - THE HEAVY CONTINUOUS TRACE FOLLOWS THE PRIMARY SIGNAL PATH THROUGH THE CIRCUIT. THE HEAVY BROKEN TRACE SHOWS FEEDBACK PATHS.
  - WIRE COLOR CODES ARE GIVEN FOR THE MAIN POWER SUPPLY AND SOME BOARD WIRES.
  - ALL RESISTORS IN OHMS UNLESS OTHERWISE STATED.
  - ALL CAPACITORS IN MICRO-FARADS UNLESS OTHERWISE STATED.
  - COMPONENTS COMMON TO BOTH CHANNELS ARE NUMBERED FROM 1 TO 99.
  - CHANNEL ONE COMPONENTS ARE NUMBERED FROM 100 TO 199.
  - CHANNEL TWO COMPONENTS ARE NUMBERED FROM 200 TO 299.
  - FOR MONO CONVERSION TIE POINT A TO B AND C TO D.
  - R108 AND R208 SHOULD BE 3.3K, 1/4W WHEN IC1 IS NA749.



**CROWN D150**  
 Laboratory Power Amplifier  
 MI 261A  
 FAIRCHILD OUTPUTS

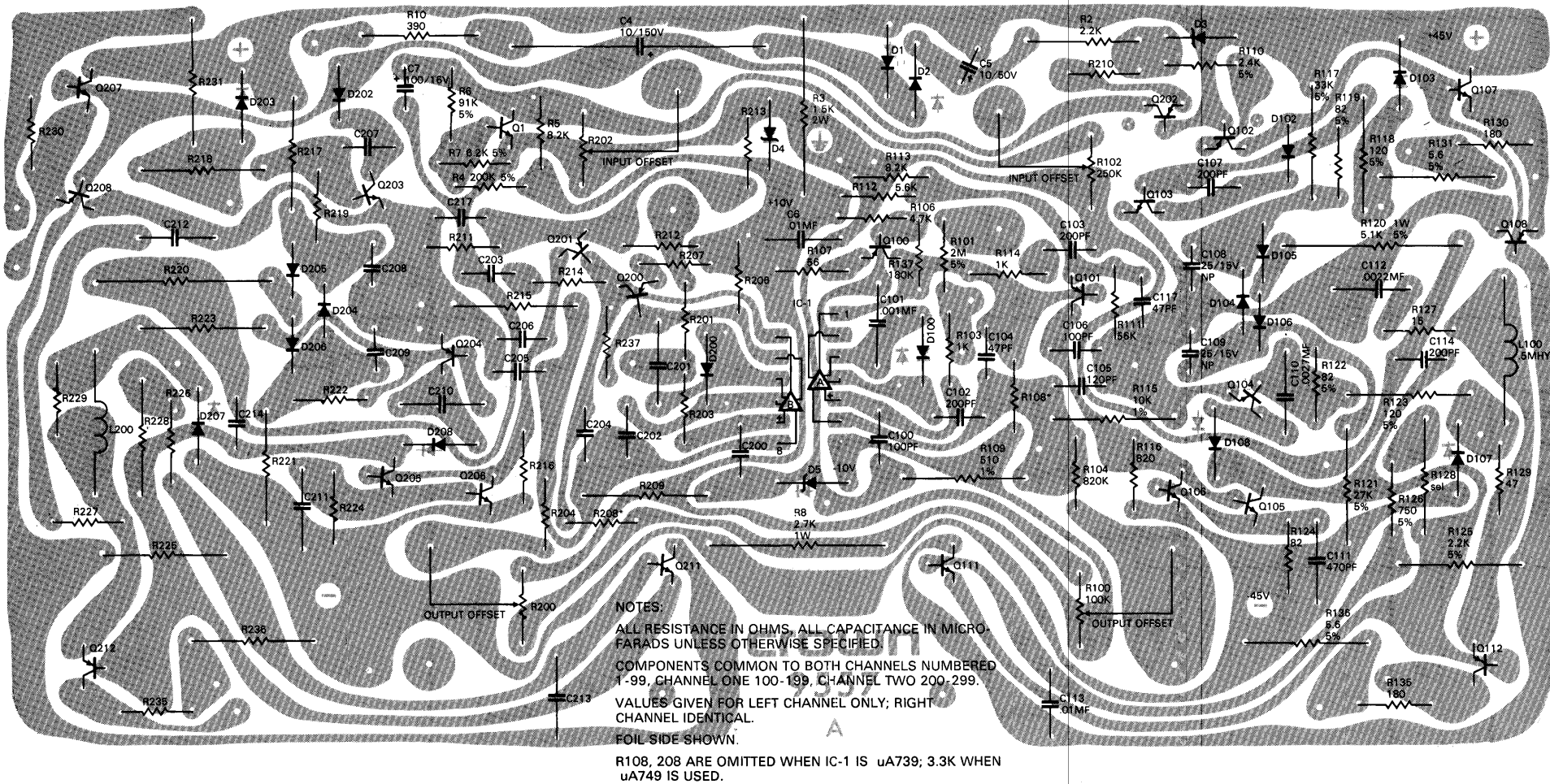


Fig. 6.4 MI-261A Foil Board Layout